

Undersidan på glasskivan ligger 5 mm under centrum av nedre fäste

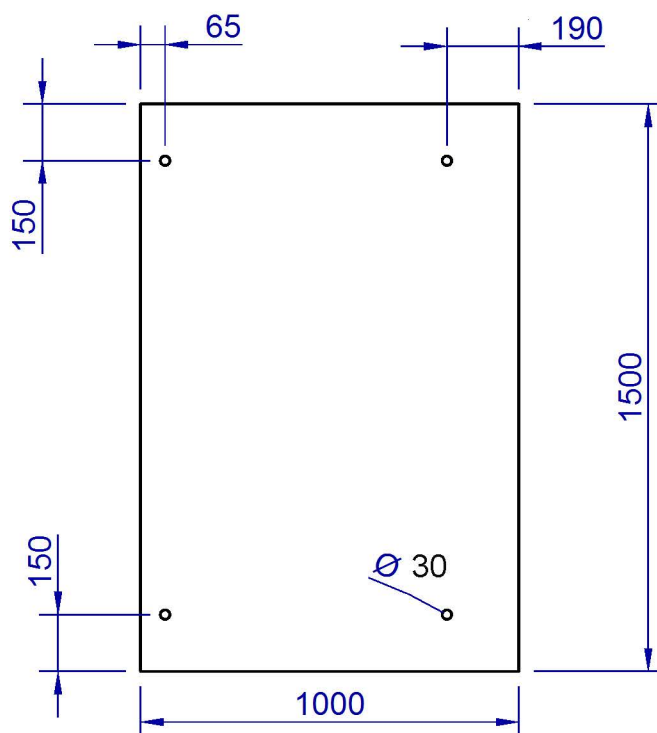

A4  ISO E	CAD ritning 3D-fil tillgänglig  Skala:	Generella toleranser enligt: ISO 2768-1 medium	Filnamn:		Senast sparad:
			Vikt: 48kg	Material: 316 syrafast	Skapad datum: 2014-10-02
			ESTRAD 1500		Bladnr: 1 (1) ...
					Rev. ...
					Ritningsnr: